

USER MANUAL

MODEL EX-60C-24

VPR 4EVER CLASSIC MODEL EX-60C-24

DESCRIPTION

The VPR 4Ever series deep cycle lithium battery is designed for RV, marine, and off-grid power storage. It uses Lithium Iron Phosphate (LiFePO₄/LFP) as its battery chemistry. LFP is considered the best choice for this application because of its high degree of safety, long service life, and excellent dependability. The VPR uses cylindrical 26650 sized stainless steel encased LFP cells. The cells are UL 1642 listed, meeting the highest standard in safety and performance. All internal power distribution cables are mechanically connected (bolted) rather than soldered to promote efficient power delivery with less resistance while providing a robust physical connection point. The power distribution plates connecting the cells, BMS, and internal terminals are solid machined copper. The unique and proprietary case contains structural elements to protect the battery pack and battery management system (BMS) inside from the effects of vibration and movement. The oversized power terminals provide a unique electrical and physical connection point for higher gauge power cables and our unique parallel bus bars.

BATTERY MANAGEMENT SYSTEM (BMS)

See the technical specification page for BMS disconnect settings.

Cell Balancing: The BMS's primary function is to provide even charging and discharging of the individual LFP cells within the internal battery pack.

Short Circuit Protection: If a short circuit occurs, the BMS will disconnect the circuit to protect the cells. When the short circuit condition is corrected, the BMS will automatically reset.

Over Charge Protection: The BMS will limit the charge voltage to protect the cells. If the high voltage condition has not been resolved or gets too high, the BMS may completely disconnect the circuit. When the condition is corrected, the BMS will automatically reset.

Over-Discharge Protection: The BMS will disconnect the circuit when the battery reaches its minimum voltage to protect the cells. If this occurs, to reset the BMS, add a charge source to the battery or connect to another battery as if jump starting. Some charge sources will not charge when they detect an open circuit as they will when the BMS has disconnected it. We recommend active power management using a battery monitoring system (coulomb counter) like the Expion360 model to prevent this from occurring.

Current Limiting Protection: The BMS will limit the charge and discharge current to protect the cells. If the high current condition is not resolved or becomes too high, the BMS will completely disconnect the circuit. The BMS will automatically reset when the high current condition is corrected.

Thermal Protection: The BMS will disconnect the circuit if the temperature gets too high while charging or discharging the battery to protect the cells. The BMS will automatically connect the circuit when operating temperatures are met.

MULTIPLE BATTERY CONNECTION

See the [series and parallel connection diagram page](#) for information.

Parallel Connection: The VPR can be parallel connected with up to 4 batteries in a single string. By parallel connecting the VPR, the available capacity, charge, and discharge rate will increase by the amount per battery up to the maximum allowable of four batteries. See the parallel connection specification section for multi battery figures. See the series and parallel connection diagram page for more information.

Series Connection: The VPR can be series connected with up to 4 batteries to increase the system voltage by the amount per battery while maintaining a single battery's capacity, charge, and discharge rating. A single battery will provide 12VDC, two batteries 24VDC, three batteries 36VDC, and four batteries will provide 48VDC. See the series connection specification section for multi battery figures. See the series and parallel connection diagram page for more information.

CHARGE PROFILE

CC/CV 2-Stage Charge Profile: The recommended charge profile for the VPR LFP battery to fill it entirely and rapidly is a two-stage process known as constant current (bulk or boost) constant voltage (absorption or saturation) at a charge voltage of 14.4-14.6V (14.4V preferred). The constant current stage will provide the charger's full rated current, minus load if connected until the full charge voltage has been achieved. The battery is approximately 97% full and will now transition to the constant voltage stage. The constant voltage stage will hold the full charge voltage while gradually decreasing the current to zero or near zero. This stage will take 15-20Min on average. The charger will then enter a standby mode waiting for the batteries voltage to drop to provide another charge cycle.

CC Single Stage Charge Profile: The VPR battery does not need to be charged entirely on each charge cycle. Therefore, a single-stage constant current charge profile at 14.4-14.6V (14.4V preferred) to charge the battery to approximately 97% full can be used.

Multi-Stage (3 or 4) Charge Profile: The 3 or 4 stage charge profile primarily designed for flooded, AGM, and Gel lead-acid batteries is not recommended for the VPR LFP battery. The VPR does not require a float stage because of its low self-discharge rate. The VPR also does not require an equalization stage because it does not sulfate when left at a state of charge less than 100% for a long period. Equalization can raise the charge voltage to above 14.6V. This higher voltage will cause the BMS on the VPR to disconnect due to an overvoltage condition. If there is no equalization or exceeds 14.6V, a multi-stage charger can be used to charge the VPR. It may not fill the battery to 100% and will charge very slowly.

CHARGE RATE

The charge rate for the VPR is based on the capacity of the battery and how many are connected in parallel. With each battery connected in parallel, the available charge rate is increased by the amount allowed per battery up to the maximum of four batteries. The optimum charge rate will promote longer life cycles for the battery. The maximum charge rate is reasonable to use when rapid power recovery is essential. We recommend using the optimum rate for most charging. See the technical specifications page for the single battery optimum and maximum charge rates.

INSTALLATION

The VPR can be installed in an outside RV battery box, as it is IP54 rated. If the VPR is installed in a battery box, make sure it has drain holes to prevent water from filling the box. Because the VPR does not exhaust any harmful fumes, it can be installed inside a trailer, motorcoach, truck camper, or boat cabin. We recommend an inside installation if operating the batteries below 32°F. Because the VPR contains no liquid electrolyte, it also can be installed in any position. Make sure the VPR is attached securely to the RV or boat to prevent its movement. When connecting using our parallel bus bars or power cables, tighten the M8x1.25 hex bolts to 8Ft Lbs. (96In Lbs.) pressure using an adjustable torque wrench. Use dielectric grease on all connections to protect from moisture and dirt, preventing oxidation. Make sure all connections are protected from short circuits. Ensure all cables and circuit protection (fuse or circuit breaker) are the proper size for the entire power system. Included with the battery are three different bolt sizes listed below.

CHARGING OPTIONS

Converter Charger: Choose a 14.4-14.6V CC/CV 2-stage model (see 5.1) for the best charge performance. The rated charge current will need to match the model and the number of batteries being charged. See the technical specification page for the single battery charge rate.

Inverter Charger: Inverter Chargers can be programmed to charge the VPR LFP battery using their available remote-control units. If the inverter charger has the recommended CC/CV (see 5.1) setting in the setup menu, generally under the "battery type" category, choose that setting. For the charge voltage, choose 14.4V. Some inverter chargers will only have the "Custom" option. This setting will also work well. There will also be additional settings to enter that are determined by the complete power system design and personal preferences. Please contact Expion360 technical support for help with programming the inverter charger.

Portable Charger: Expion360 has its own 20A CC/CV 2-stage 14.6V portable charger. This charger is compact and simple to use to charge any model of battery in the VPR line. It can be added as a supplemental charge source when rapid power recovery is important or simply as a bench charger. It can also be used to charge other LiFePO4/LFP batteries that meet its specification.

Solar Charging: This is charging using a portable or fixed solar panel(s) regulated using a solar charge controller. Choose a solar charge controller that can program to 2 stage charging or one with a lithium setting abbreviated as LiFePO4 or LFP. If using a programable model, set the charge voltage to 14.4-14.6V (14.4V preferred). To prevent charging below 32°F, install a solar switch between the solar panels and the charge controller. Make sure the switch is adequately sized to handle the voltage and current of the solar system.

Mobile Charger: This is charging using a DC to DC boost charger drawing power from the vehicle battery while the alternator is running. The charger should be able to be programmed for LFP for the best charge performance. Expion360 has its own 25A 14.6V 2-stage model designed only to charge LiFePO4/LFP. Two of our chargers can be used in parallel to get a 50A charge rate. This model is simple to install and use. The Expion360 25A mobile charger can be used with other LiFePO4/LFP chemistry batteries that meet its specification.

DISCHARGE RATE

The discharge rate, just like the charge rate, is based on the batteries capacity and how many batteries are connected in parallel. With each battery connected in parallel, the available discharge rate is increased by the amount allowed per battery up to the maximum amount of four batteries. The continuous discharge rate should not be exceeded unless for temporary surge purposes. The maximum and pulse discharge rates are provided to maintain a surge at or below these levels. The VPR is designed for deep cycle use do not use as a starter battery. See the technical specifications page for single battery continuous, maximum, and pulse discharge rates.

INVERTER USE

When using an inverter powered by the VPR battery(s), make sure to properly match the inverter size (wattage) to the number of batteries used. When viewing the inverter's DC input specifications, consider the surge current and the batteries' continuous current required to power the inverter. The maximum surge and continuous DC input current for the inverter and maximum surge and continuous output current for the VPR battery(s) need to match closely. Suppose the VPR battery(s) DC output is higher than the inverter input. In that case, that is acceptable because the inverter will only draw from the batteries what it needs. The inverter cannot have a higher DC input than the battery(s) DC output. It can draw more current from the VPR Battery(s) than they can supply, possibly causing the BMS on the VPR to disconnect due to over-discharge.

BATTERY MONITORING

To enhance the VPR 4Ever series battery experience, we recommend using a battery monitoring system that measures coulombs rather than just voltage. When using voltage alone to determine a lithium batteries state of charge, it is difficult because its discharge curve is flat compared to a lead-acid battery. The VPR LFP battery will remain between 13.0-13.2V (open circuit) for much of its discharge cycle. The Expion360 battery monitor is an excellent choice as it is very accurate for lithium, easy to program, and use. It shows capacity in amp hours and as a percentage. It has a time counter that will display the time until empty when discharging and time until full while charging. It will also show power going out while discharging and in while charging as current (DC amperage) and watts. It will lastly show the battery's voltage. The Expion360 battery monitor will work for other brands of LiFePO4/LFP batteries and lead-acid chemistry batteries.

BATTERY LIFE

Many factors can determine the VPR life span or life cycles (charge/discharge cycle). The main element is the depth of discharge on each discharge cycle before recharging the battery. The deeper the battery's discharge on each cycle, the lower the expected life cycles the battery will have. This depth of discharge life cycle equation is a fact for all battery chemistries. The VPR is not damaged by deeply discharging it; only the life cycles are affected. The VPR can be recharged at any point in its state of charge without harming the battery. Other aging factors that can affect life cycles are charging and discharging the battery at higher than recommended rates and operating the battery at extremely low and high temperatures. When we established specifications for using the VPR, we have considered both safety and maximum life cycles. Please follow the specifications for the discharge rate, charge rate, and operating temperatures.

VOLTAGE READINGS

It is essential to understand the voltage readings of the VPR and how they relate to the battery state of charge. Three voltage readings are essential to know, the full charge voltage, full resting voltage, and empty voltage of the VPR. The full charge voltage of the VPR when using a 2-stage constant current constant voltage lithium profile charger will be 14.4-14.6V depending on the charger voltage output. The full charge voltage is a higher voltage than the full resting voltage of the VPR to allow the power to be pushed into the battery. If the full charge voltage and full resting voltage matched, no charge will occur. The full resting voltage of the VPR is $13.4\pm 0.1V$ when the battery has been completely charged, and all charge and load sources are disconnected or shut off completely. The empty voltage of the VPR is 10.5V, and at this point, the battery will need to be recharged. If the VPR is allowed to fall below 10.5V, there is a high risk, it will shut off due to a low voltage state at $9.2\pm 0.1V$ and will need to be reset. When the VPR is charging or in a higher state of charge than discharge, the battery will have a falsely high voltage reading. When the battery is discharging or in a higher state of discharge than charge, the battery will have a falsely low voltage reading. Due to the flat discharge curve of the VPR is very difficult to determine the battery state of charge based on its voltage reading, unlike a lead-acid battery.

BATTERY STORAGE

The optimum state of charge to store the VPR for long-term storage, more than three months, is 40-80% or when the batteries open circuit voltage is approximately 13.2V. Open circuit voltage is the voltage reading of the battery with no charge or load applied, sometimes referred to as the resting voltage. This state of charge will allow for a small amount of self-discharge that all batteries experience. Unlike lead-acid batteries, the self-discharge rate of the VPR is meager at 1-2% monthly. The VPR is not damaged by being stored partially full; therefore, it does not require any maintenance charge (float). The VPR should be completely disconnected from any charge or load while in long term storage. This disconnect will prevent charging below 32°F or a load draining the battery until the BMS disconnects due to a low voltage condition. Leaving the battery disconnected due to a low voltage condition for long periods before recharging is not suitable for the lithium cells and can shorten the battery's life cycles. Even a small amount of parasitic draw over time will drain the battery; therefore, we recommend disconnecting the battery terminals when in long term storage.

ACCESSORIES

The products listed below are just a few items Expion360 manufactures that are available for use with this battery. For questions regarding these products, please email support@expion360.com.

Model EV-BM350: Battery monitor with display, 500A shunt, 35' cable, and mounting bracket.

Model EX-25DC: Expion360 mobile DC to DC 25A 14.6V 2-stage charger for motorcoach use only.

Model EX-V120-C20A: Expion360 portable 20A 14.6V 2-stage LFP charger with alligator clips.

Model EX-24-TDS: VPR battery tie-down system to secure the battery to an RV or Boat floor.

MODEL EX-100C-27 TECHNICAL SPECIFICATIONS

ELECTRICAL PARAMETERS

NOMINAL VOLTAGE	12.8V
RATED CAPACITY	60Ah
ENERGY	768Wh
RESISTANCE	≤50mΩ
EFFICIENCY	99%
CYCLE LIFE @ 1C, 100% DOD	≥2000 CYCLES
SELF DISCHARGE	≤2% PER MONTH
CELL CHEMISTRY	LiFePO4 / LFP

MECHANICAL PARAMETERS

DIMENSIONS (L X W X H) INCHES	10.24 X 6.81 X 8.59
WEIGHT	17.42lbs
TERMINAL TYPE	M8 - 1.25
CASE TYPE	ABS PLASTIC
CASE PROTECTION	IP54
CASE FLAMABILITY RATING	UL-94 VO
CELL PACK CONFIGURATION	4S18P
CELL UL LISTING	UL1642 FILE #MH64383
CELL SIZE	26650 CYLINDRICAL
CELL CAPACITY	3400mAh / 3.4Ah
BATTERY PARALELL CONNECTION	MAXIMUM 4 / 240Ah
BATTERY SERIES CONNECTION	MAXIMUM 4 / 48V

DISCHARGE PARAMETERS

CONTINUOUS DISCHARGE	50A
MAXIMUM DISCHARGE	60A (30 SEC)
PULSE DISCHARGE	80A (1 SEC)
MINIMUM VOLTAGE	10.5V
BMS SHORT CIRCUIT DISCONNECT	200-600μs
BMS LOW VOLTAGE DISCONNECT / RECONNECT	9.2±0.1V / 10.8±0.4V
BMS OVER CURRENT DISCONNECT	160±25A

CHARGE PARAMETERS

CHARGE PROFILE	CC/CV 2 STAGE
RECOMMENDED CHARGE VOLTAGE	14.4V
MAXIMUM CHARGE VOLTAGE	14.6V
FULL OPEN CIRCUIT VOLTAGE	13.4±0.1V
RECOMMENDED CHARGE CURRENT	15A
MAXIMUM CHARGE CURRENT	30A
BMS OVERVOLTAGE DISCONNECT / RECONNECT	14.6±0.1V / 14.2±0.2V
BMS OVER CURRENT DISCONNECT	70±20A

TEMPERATURE PARAMETERS

DISCHARGE OPERATING TEMPERATURE	-4 TO 132°F
CHARGE OPERATING TEMPERATURE	32 TO 132°F
STORAGE TEMPERATURE	-4 TO 132°F
DISCHARGE HIGH TEMP. DISCONNECT / RECONNECT	185±9°F / 167±9°F
CHARGE HIGH TEMP. DISCONNECT / RECONNECT	149±9°F / 140±9°F
CHARGE LOW TEMP DISCONNECT / RECONNECT	32±9°F / 41±9°F

BUS BAR AND CABLE CONNECTION

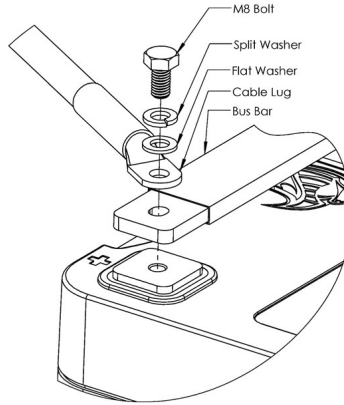

PARALLEL CONNECTION SPECIFICATIONS

VPR QTY	VOLTAGE RANGE	CHARGE RATE	DISCHARGE RATE	CAPACITY
1	12V	15-30A	50A	60Ah
2	12V	30-45A	100A	120Ah
3	12V	45-60A	150A	180Ah
4	12V	60-75A	200A	240Ah

SERIES CONNECTION SPECIFICATIONS

VPR QTY	VOLTAGE RANGE	CHARGE RATE	DISCHARGE RATE	CAPACITY
1	12V	15-30A	50A	60Ah
2	24V	15-30A	50A	60Ah
3	36V	15-30A	50A	60Ah
4	48V	15-30A	50A	60Ah

PARALLEL CONNECTION

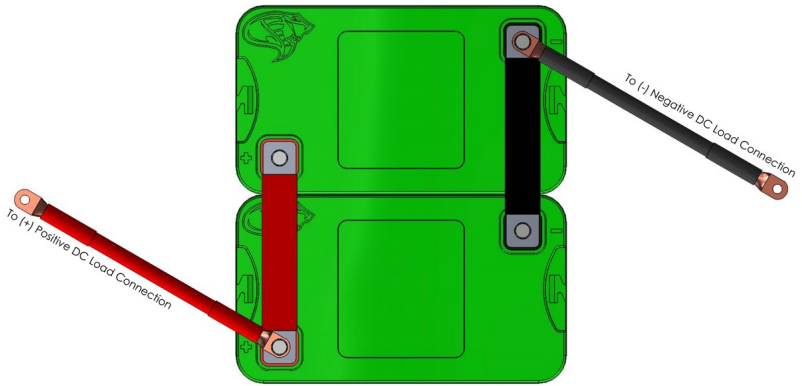



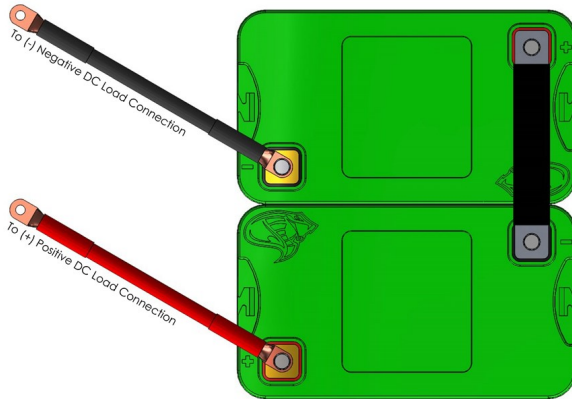













SERIES CONNECTION



NOTICE

TO PREVENT DAMAGE AND EXTEND BATTERY LIFE PLEASE FOLLOW THESE PRECAUTIONS

-  DO NOT DROP THE BATTERY
-  DO NOT OPEN THE BATTERY
-  DO NOT SHORT CIRCUIT THE BATTERY
-  DO NOT SUBMERGE THE BATTERY IN WATER
-  DO NOT CHARGE THE BATTERY ABOVE 14.6V
-  DO NOT USE THE BATTERY AS A STARTER BATTERY
-  DO NOT CHARGE THE BATTERY AT OR BELOW 32°F
-  DO NOT CONNECT MORE THAN 4 BATTERIES IN SERIES
-  DO NOT CONNECT MORE THAN 4 BATTERIES IN PARALLEL
-  DO NOT DISCHARGE THE BATTERY BELOW 10.5V - EMPTY
-  DO NOT ATTEMPT REPAIR OF THE BATTERY IF MALFUNCTIONING
-  DO NOT CHARGE THE BATTERY ABOVE ITS MAXIMUM CHARGE RATE
-  DO NOT USE A CHARGER WITH AN EQUALIZATION STAGE ABOVE 14.6V
-  DO NOT DISCHARGE THE BATTERY ABOVE ITS MAXIMUM DISCHARGE RATE
-  DO NOT LEAVE THE BATTERY CONNECTED TO RV CABLES WHEN IN STORAGE
-  DO NOT USE A CHARGER WITH AN EQUALIZATION STAGE AT VOLTAGES ABOVE 14.6

EXPION360 TRUE 12 WARRANTY

Expion360 warrants each Expion360 branded VPR 4EVER Classic and Platinum batteries sold by Expion360 or any of its authorized dealers, distributors, and OEM partners to be free of defects for 12 years from the date of sale as determined by the customer's sales receipt for proof of purchase.

0-8 YEARS

Within the first eight years of the warranty period, subject to the exclusions listed below, Expion360 will repair or replace the battery and or parts of the components in question are determined to be defective in material and or workmanship.

8-10 YEARS

After eight years and up to 10 years, if the components in question are determined to be defective in material and or workmanship, and Expion360 at its sole discretion deems the battery repairable, the battery will be repaired and returned. If Expion360 deems the components unrepairable, a new similar battery will be offered at a discount of 40% off the published market price listed at the time of the offer. The offer is valid for 60 days after a representative from Expion360 has contacted the customer with the repairability decision.

10-12 YEARS

After ten years and up to 12 years, if the components in question are determined to be defective in material or workmanship, and Expion360 deems the components to be repairable, the Battery will be repaired and returned. If Expion360 deems the components not repairable, a new, similar Battery will be offered at a discount of 20% off the published market price listed at the time of the offer. The offer is valid for 60 days after a representative from Expion360 has contacted the customer with the repairability decision.

INSTALLATION

Expion360 recommends professional installation by a qualified RV, Marine, or 12VDC technician. However, the full warranty applies whether professionally installed or not if installation instructions are followed in the User Manual.

NON-TRANSFERABLE

This Limited Warranty is for the original purchaser only and is not transferable to any other person or entity.

WARRANTY EXCLUSIONS

Expion360 has no obligation under this Limited Warranty for any VPR 4EVER Classic or Platinum Battery subject to the following conditions (including but not limited to):

- Damage caused by road debris or collision.
- Damage due to over/undercharging, over-discharging, under-sizing for application, not using surge limiting device in specific applications, and reverse polarity connections.
- Damage due to improper installations, incorrect wire sizing, loose connections, improper parallel and series connections, not maintaining terminals, and oversizing inverters (see owner's manual for proper inverter sizing).
- A battery that has been opened, tampered with, and or modified.
- They are used in any starting application or any other application not intended.
- Environmental damage, improper storage conditions as defined in the owner's manual, water, or moisture damage, freezing, fire, and extreme weather exposure.

WARRANTY DISCLAIMER

THIS LIMITED WARRANTY REPRESENTS THE TOTAL LIABILITY OF EXPION360 FOR ANY BATTERY. ALL OTHER WARRANTIES IMPLIED BY LAW APPLICABLE TO THE BATTERY SHALL BE LIMITED TO THE WARRANTY PERIOD STATED. EXPION360 MAKES NO OTHER WARRANTIES, EXPRESS OR IMPLIED, INCLUDING THE IMPLIED WARRANTIES OF MERCHANTABILITY OR FITNESS FOR A PARTICULAR PURPOSE. EXPION360 SHALL NOT BE LIABLE FOR ANY INDIRECT, SPECIAL, INCIDENTAL, OR CONSEQUENTIAL DAMAGES.

LEGAL RIGHTS

Some states do not allow limitations on how long an implied warranty lasts or exclusion or limitation of incidental or consequential damages, so the above limitations may not apply to you. This warranty gives you specific legal rights, and you may also have other rights that vary from state to state. This warranty shall be governed by and interpreted by the laws of Oregon. This warranty is understood to be the exclusive agreement between the parties relating to the subject matter hereof. No employee or representative of Expion360 is authorized to make any warranty in addition to those made in this agreement.

SUBMITTING A WARRANTY CLAIM

To submit a warranty claim, please contact Expion360 at support@expion360.com

EXPION360

(541) 797-6714

support@expion360.com

expion360.com